



Features

- SFP Multi-Source Agreement compliant
- Compliant with IEEE802.3z Gigabit Ethernet Standard
- Compliant with Fiber Channel 100-SM-LC-L standard
- Industry standard small form pluggable (SFP) package
- Simplex LC connector
- Differential LVPECL inputs and outputs
- Single power supply 3.3V
- TTL signal detect indicator
- Hot Pluggable
- Class 1 laser product complies with EN 60825-1
- RoHS Compliant

Absolute Maximum Ratings

Parameter	Symbol	Min.	Max.	Units	Note
Storage Temperature	T_s	-40	85	°C	
Supply Voltage	V_{CC}	-0.5	4.0	V	
Input Voltage	V_{IN}	-0.5	V_{CC}	V	

Recommended Operating Conditions

Parameter	Symbol	Min.	Max.	Units	Note
Case Operating Temperature	T_C	0	70	°C	
Supply Voltage	V_{CC}	3.1	3.5	V	
Supply Current	$I_{TX} + I_{RX}$	---	300	mA	
Dispersion tolerance	DS	-450	2400	ps/nm	
Dispersion Penalty	P	---	1.0	dB	

Transmitter Electro-optical Characteristics

V_{cc} = 3.1 V to 3.5 V, T_c = 0 °C to 70 °C

Parameter	Symbol	Min.	Typ.	Max.	Units	Note
Output Optical Power 9/125 μm fiber	P_{out}	-2	---	+3	dBm	Average
Extinction Ratio	ER	9	---	---	dB	
Center Wavelength	λ_c	1560	1570	1580	nm	
Spectral Width (-20dB)	λ	---	---	0.5	nm	
Side Mode Suppression Ratio	$SMSR$	30			dB	
Rise/Fall Time (20–80%)	$T_{r, f}$	---	---	260	ps	
Relative Intensity Noise	RIN	---	---	-120	dB/Hz	
Total Jitter	TJ	---	---	227	ps	
Output Eye		Compliant with IEEE802.3z				
Max P_{out} TX-DISABLE Asserted	P_{OFF}	---	---	-45	dBm	
Differential Input Voltage	V_{DIFF}	0.4	---	2.0	V	
Transmit Fault Output-Low	TX_FAULT_L	0.0	---	0.5	V	
Transmit Fault Output-High	TX_FAULT_H	2.4	---	V _{cc}	V	
Time to initialize, include reset of TX_FAULT	t_{init}	---	---	300	ms	
TX_FAULT from fault to assertion	t_{fault}	---	---	100	μs	
TX_DISABLE time to start reset	t_{reset}	10	---	---	μs	

Receiver Electro-optical Characteristics

$V_{CC} = 3.1 \text{ V to } 3.5 \text{ V}$, $T_c = 0^\circ \text{C to } 70^\circ \text{C}$

Parameter	Symbol	Min.	Typ.	Max.	Units	Note
Optical Input Power-maximum	P_{IN}	-8	---	---	dBm	BER < 10^{-12}
Optical Input Power-minimum (Sensitivity)	P_{IN}	---	---	-33	dBm	PRBS7, BER < 10^{-12}
Operating Center Wavelength	λ_C	1500	---	1520	nm	
Optical Return Loss	ORL	14	---	---	dB	$\lambda=1500\sim 1520\text{nm}$
Loss of signal-Asserted	P_A	---	---	-33	dBm	
Loss of signal-Deasserted	P_D	-45	---	---	dBm	
Differential Output Voltage	V_{DIFF}	0.5	---	1.2	V	
Data Output Rise, Fall Time (20%-80%)	$T_{r, f}$	---	---	0.35	ns	
Receiver Loss of Signal Output Voltage-Low	RX_LOS_L	0	---	0.5	V	
Receiver Loss of Signal Output Voltage-High	RX_LOS_H	2.4	---	V_{CC}	V	

Block Diagram of Transceiver

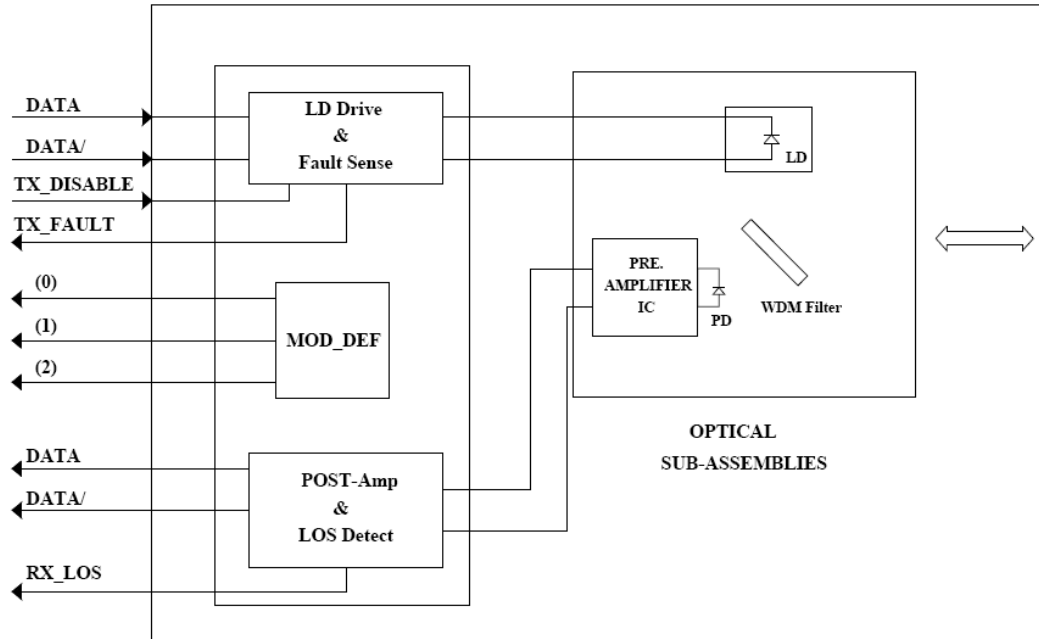

Transmitter and Receiver Optical Sub-assembly Section

A 1570 nm InGaAsP laser and an InGaAs PIN photodiode integrate with a WDM filter to form a bi-directional single fiber optical subassembly (OSA). The laser of OSA is driven by a LD driver IC which converts differential input LVPECL logic signals into an analog laser driving current. And, The photodiode of OSA is connected to a circuit providing post-amplification quantization, and optical signal detection.

TX_FAULT

When sensing an improper power level in the laser driver, the SFP set this signal high and turns off the Laser. TX_FAULT can be reset with the TX_DISABLE line. The signal is in TTL level.

TX_DISABLE

The TX_DISABLE signal is high (TTL logic "1") to turn off the laser output.

Receive Loss (RX_LOS)

The RX_LOS is high (logic "1") when there is no incoming light from the companion transceiver. This signal is normally used by the system for the diagnostic purpose. The signal is operated in TTL level.

Pin Assignment

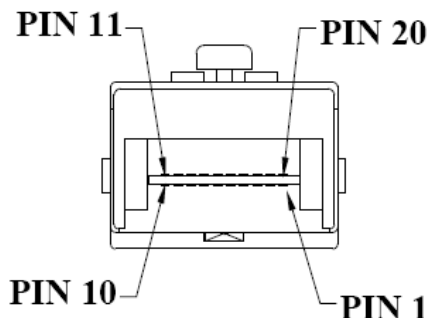

Pin Descriptions

Pin	Signal Name	Description
1	T _{GND}	Transmitter Ground
2	TX_FAULT	Transmit Fault
3	TX_DISABLE	Transmit Disable
4	MOD_DEF(2)	SDA Serial Data Signal
5	MOD_DEF(1)	SCL Serial Clock Signal
6	MOD_DEF(0)	TTL Low
7	RATE SELECT	Open Circuit
8	RX_LOS	Receiver Loss of Signal, TTL High, Open collector
9	R _{GND}	Receiver Ground
10	R _{GND}	Receiver Ground
11	R _{GND}	Receiver Ground
12	RX-	Receive Data Bar, Differential PECL, ac coupled
13	RX+	Receive Data, Differential PECL, ac coupled
14	R _{GND}	Receiver Ground
15	V _{CCR}	Receiver Power Supply
16	V _{CCT}	Transmitter Power Supply
17	T _{GND}	Transmitter Ground
18	TX+	Transmit Data, Differential PECL, ac coupled
19	TX-	Transmit Data Bar, Differential PECL, ac coupled
20	T _{GND}	Transmitter Ground

Dimensions

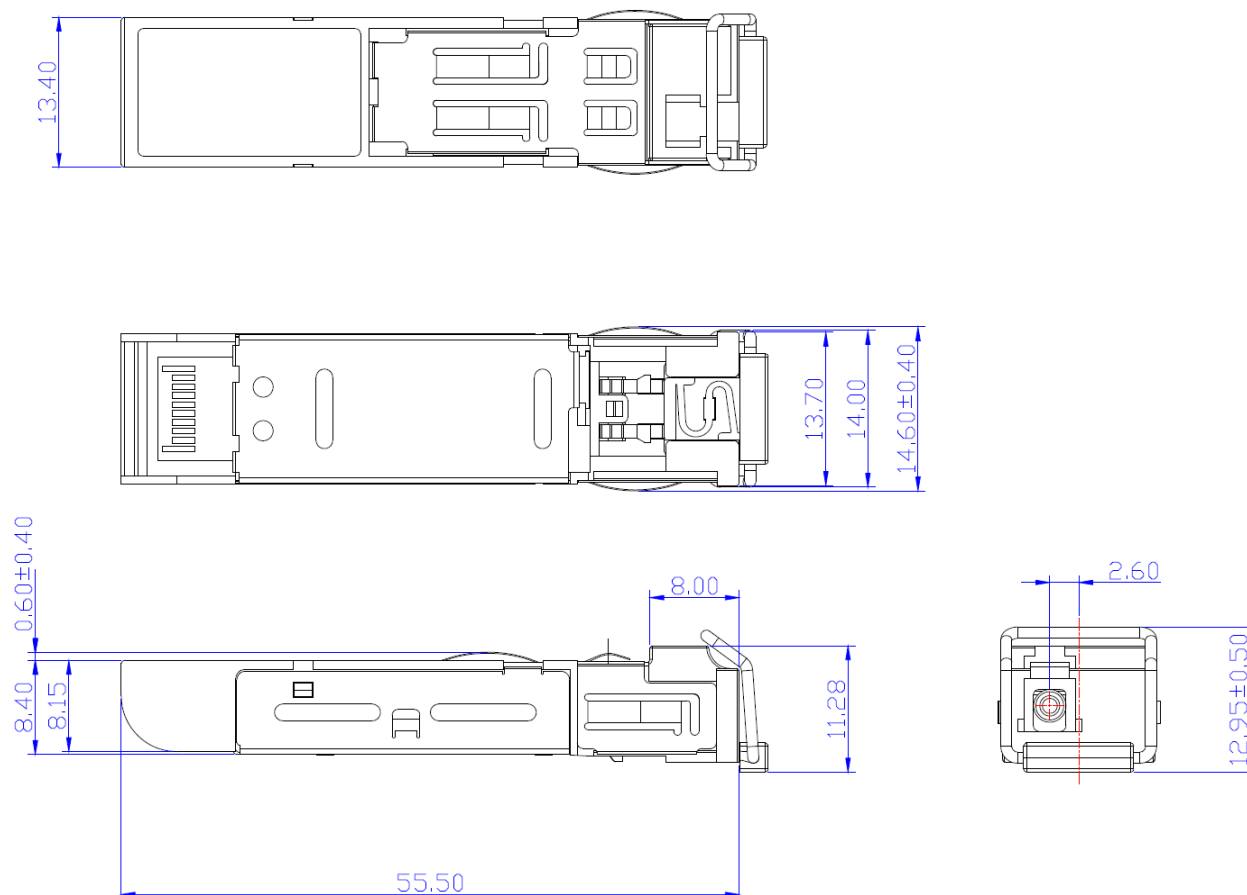

DIMENSIONS ARE IN MILLIMETERS

ALL DIMENSIONS ARE ±0.2mm UNLESS OTHERWISE SPECIFIED

Ordering Information

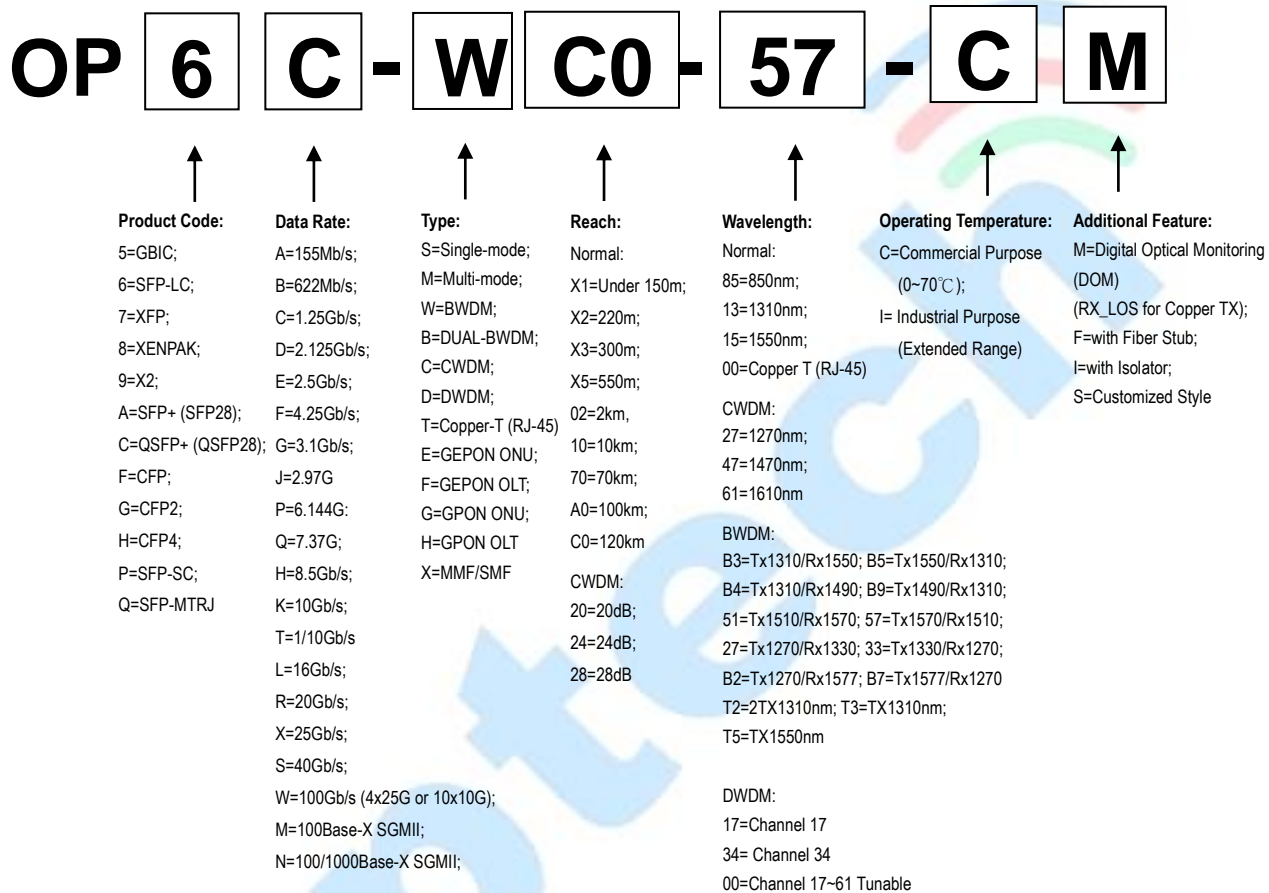

Model Number	Part Number	Reach	TX/RX	Input/Out	Signal Detect	Temperature	LD Type
SFP-BWDM-120-57	OP6C-WC0-57-C	120 km	1570/1510	AC/AC	TTL	0°C to 70 °C	1570 DFB

Note: All information contained in this document is subject to change without notice.