



Features

- Compliant to IEEE802.3by 25GBASE-SR
- 25Gb/s 10GE optical interface
- 25G 850nm VCSEL transmitter
- 25G PIN photo-detector
- 2-wire interface for management specifications compliant with SFF-8472 digital diagnostic monitoring interface for optical transceivers
- Operating case temperature: 0 to 70°C
- All-metal housing for superior EMI performance
- 25G electrical interface (OIF CEI-28G-VSR)
- Maximum power consumption 1.0W
- Advanced firmware allow customer system encryption information to be stored in transceiver
- RoHS compliant

Applications

- High-speed storage area networks
- Computer cluster cross-connect
- Custom high-speed data pipes
- Inter Rack Connection

Absolute Maximum Ratings

Parameter	Symbol	Min.	Max.	Units	Note
Storage Temperature	T_c	-40	85	°C	
Operating Case Temperature	T_c	0	70	°C	
Supply Voltage	V_{cc}	0	3.6	V	
Relative Humidity	RH	5	85	%	
Damage Threshold	THd	3.4		dBm	

Recommended Operating Conditions

Parameter	Symbol	Min	Typical	Max	Units
Operating Case Temperature	Tc	0		70	°C
Power Supply Voltage	Vcc	3.135	3.3	3.465	V
Data Rate, each Lane			25.78125		Gb/s
Data Rate Accuracy		-100		100	ppm
Control Input Voltage High		2		Vcc	V
Control Input Voltage Low		0		0.8	V

Link Distances

Fiber type	850nm OFL Bandwidth	Supported Distances (meters)
50µm MMF	OM4 3500 MHz-km	0.5 to 100
50µm MMF	OM3 2000 MHz-km	0.5 to 70

SFP28 SR Operating Range for each Optical Fiber Type

Diagnostics

Parameter	Symbol	Accuracy	Unit	Notes
Temperature monitor absolute error	DMI_Temp	± 3	°C	Over operating Temp
Supply voltage monitor absolute error	DMI_VCC	± 0.1	V	Full operating range
RX power monitor absolute error	DMI_RX	± 2 dB	dBm	1
Bias Current monitor	DMI_Bias	± 10%	mA	
Laser power monitor absolute error	DMI_TX	± 2 dB	dBm	1

Notes:

- Due to measurement accuracy of different single mode fibers, there could be an additional +/-1 dB fluctuation, or a +/- 3 dB total accuracy.

Transmitter Electro-optical Characteristics

V_{cc} = 3.135 V to 3.465 V, T_c = 0 °C to 70 °C

<i>Parameter</i>	<i>Test Point</i>	<i>Min</i>	<i>Typical</i>	<i>Max</i>	<i>Units</i>	<i>Notes</i>
Power Consumption				1	W	
Supply Current	I _{cc}			300	mA	
Overload Differential Voltage pk-pk	TP1a	900			mV	
Common Mode Voltage (V _{cm})	TP1	-350		2850	mV	1
Differential Termination Resistance Mismatch	TP1			10	%	At 1MHz
Differential Return Loss (SDD11)	TP1			See CEI- 28G-VSR Equation 13-19	dB	
Common Mode to Differential conversion and Differential to Common Mode conversion (SDC11, SCD11)	TP1			See CEI- 28G-VSR Equation 13-20	dB	
Stressed Input Test	TP1a		See CEI- 28G-VSR Section 13.3.11.2.1			
Center Wavelength	λ _t	840		860	nm	
RMS Spectral Width				0.6	nm	
Average Optical Power	P _{avg}	-8.4		2.4	dBm	
Optical Power OMA	POMA	-6.4		3	dBm	2
Launch power in OMA minus TDEC	POMA - TDEC	-7.3			dBm	
Transmitter and Dispersion Eye Closure	TDEC			4.3	dB	
Extinction Ratio	ER	2			dB	
Optical Return Loss Tolerance				12	dB	
Average Launch Power OFF Transmitter	P _{off}			-30	dBm	

Parameter	Test Point	Min	Typical	Max	Units	Notes
Encircled Flux				≥86% at 19 μm ≤30% at 4.5 μm		3
Transmitter Eye Mask Definition {X1, X2, X3, Y1, Y2, Y3} - Hit ratio 1.5x10 ⁻³ hits per sample				{0.3, 0.38, 0.45, 0.35, 0.41, 0.5}		4

Note

1. Vcm is generated by the host. Specification includes effects of ground offset voltage.
2. Even if the TDEC < 0.9dB, the OMA (min) must exceed the minimum value specified here.
3. If measured into type A1a.2 or type A1a.3 50μm fiber in accordance with IEC 61280-1-4.
4. Mask margin shall be higher than 5%.

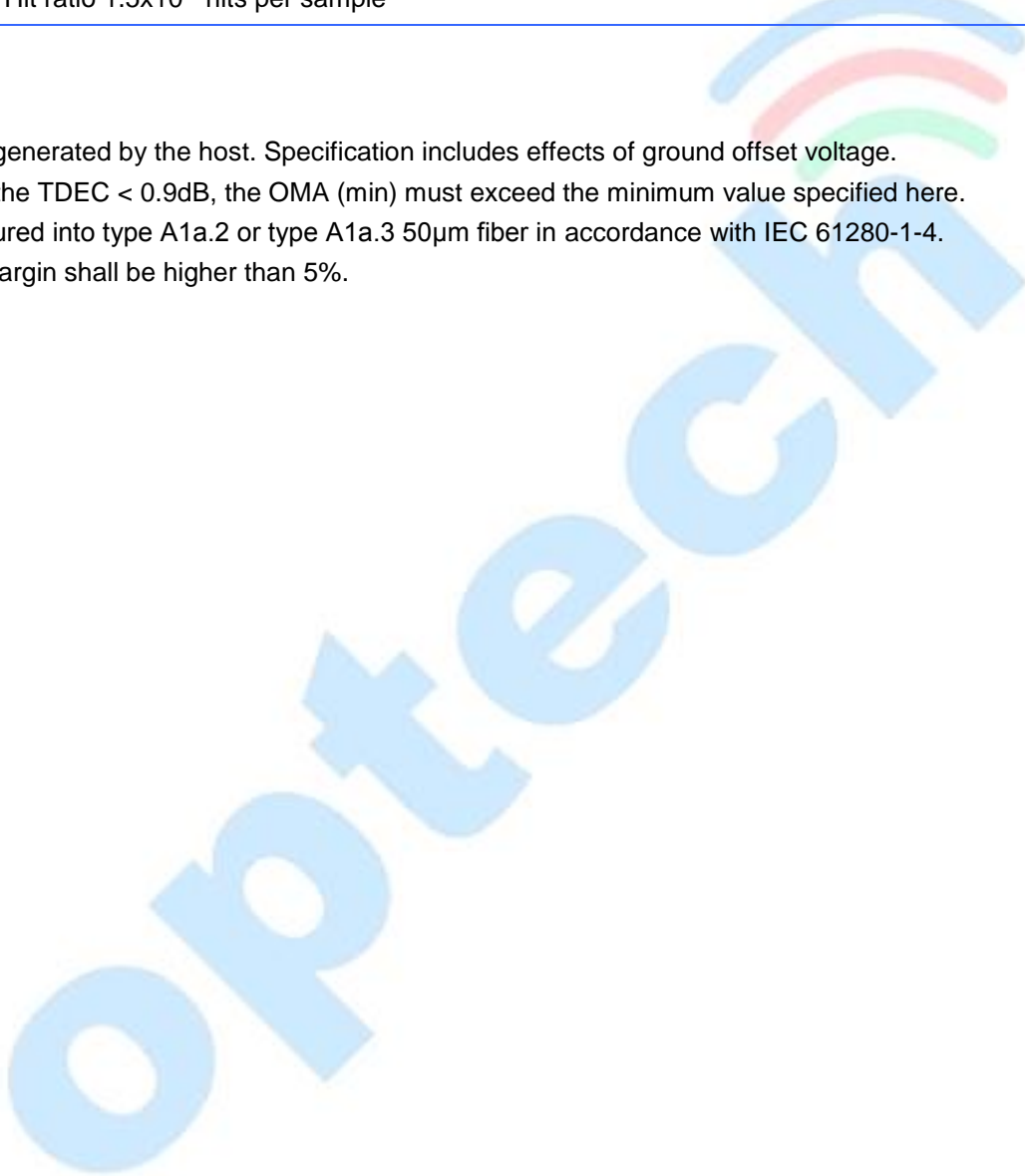

Receiver Electro-optical Characteristics

V_{CC} = 3.135 V to 3.465 V, T_C = 0 °C to 70 °C

Parameter	Test Point	Min	Typical	Max	Units	Notes
Differential Voltage, pk-pk	TP4			900	mV	
Common Mode Voltage (V _{cm})	TP4	-350		2850	mV	1
Common Mode Noise, RMS	TP4			17.5	mV	
Differential Termination Resistance Mismatch	TP4			10	%	At 1MHz
Differential Return Loss (SDD22)	TP4			See CEI- 28G-VSR Equation 13-19	dB	
Common Mode to Differential conversion and Differential to Common Mode conversion (SDC22, SCD22)	TP4			See CEI- 28G-VSR Equation 13-21	dB	
Common Mode Return Loss (SCC22)	TP4			-2	dB	2
Transition Time, 20 to 80%	TP4	9.5			ps	
Vertical Eye Closure (VEC)	TP4			5.5	dB	
Eye Width at 10 ⁻¹⁵ probability (EW15)	TP4	0.57			UI	
Eye Height at 10 ⁻¹⁵ probability (EH15)	TP4	228			mV	
Center Wavelength	λ _r	840	850	860	nm	
Damage Threshold		3.4			dBm	3
Average Receiver Power		-10.3			dBm	4
Average Receiver Power (Overload)				2.4	dBm	5
Receiver Power (OMA) (Overload)				3	dBm	6
Stressed Receiver Sensitivity (OMA)				-5.2	dBm	7
Receiver Reflectance				-12	dB	
LOS Assert	LOSA	-30			dBm	
LOS Deassert	LOSD			-12	dBm	
LOS Hysteresis	LOSH	0.5			dB	

Stressed Receiver Sensitivity Test Condition (Note 8)

Stressed Eye Closure (SEC)	SEC	4.3	dB
Stressed Eye J2 Jitter	J2	0.39	UI
Stressed Eye J4 Jitter	J4	0.53	UI
OMA of each Aggressor Lane		3	dBm
Stressed Receiver Eye Mask Definition			
{X1, X2, X3, Y1, Y2, Y3} - Hit ratio 1.5×10^{-5} hits per sample		{0.28, 0.5, 0.5, 0.33, 0.33, 0.4}	
As Sinusoidal Jitter for Receiver Conformance Test		See IEEE802.3bm Table 95-11	

Note

1. Vcm is generated by the host. Specification includes effects of ground offset voltage.
2. From 250MHz to 30GHz.
3. The receiver shall be able to tolerate, without damage, continuous exposure to an optical input signal having this average power level on one lane. The receiver does not have to operate correctly at this input power.
4. Average receive power (min) is informative and not the principal indicator of signal strength. A received power below this value cannot be compliant; however, a value above this does not ensure compliance.
5. If TX ER < 5.68dB.
6. If TX ER > 5.68dB.
7. Measured with conformance test signal at TP3 for BER specified in IEEE802.3bm 95.1.1.
8. These test conditions are for measuring stressed receiver sensitivity. They are not characteristics of the receiver.

Transceiver Block Diagram

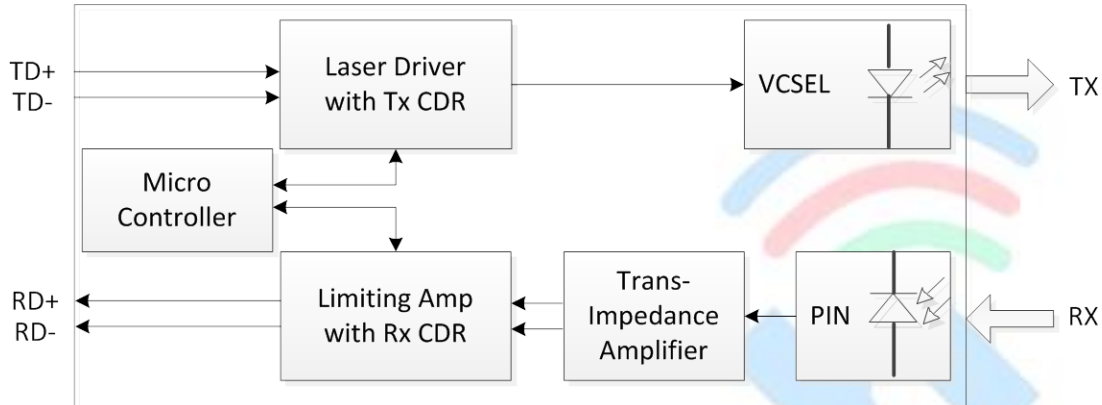

The SFP28 25G is a single-rate module with an operating range of 0.5m to 70m/100m over OM3/OM4 MMF (Table 1), respectively, compliant with IEEE802.3by 25GBASE-SR optical specs.

The module optical connection is duplex LC and shall be compatible with SFP+ 28Gbps and backward compatible with legacy 10G SFP+ pluggable. The SFP28 SR module is a dual directional device with a transmitter and receiver plus a control management interface (2-wire interface) in the same physical package. 2-wire interface is used for serial ID, digital diagnostics and module control function.

The module operates by a single +3.3V power supply. LVCMOS/LVTTL global control signals, such as Module Present, Reset, Interrupt and Low Power Mode, are available with the modules. The SFP28 SR module electrical interface is compliant to OFI CEI-VSR-28G-VSR. It has been designed to meet the harshest external operating conditions including temperature, humidity and EMI interference. The module offers very high functionality and feature integration, accessible via a two-wire serial interface.

The transmitter converts 25Gbit/s serial PECL or CML electrical data into serial optical data compliant with the 25GBASE-SR standard. An open collector compatible Transmit Disable (Tx_Dis) is provided. Logic "1" or no connection on this pin will disable the laser from transmitting. Logic "0" on this pin provides normal operation. The transmitter has an internal automatic power control loop (APC) to ensure constant optical power output across supply voltage and temperature variations. An open collector compatible Transmit Fault (Tx_Fault) is provided. TX_Fault is module output contact that when high, indicates that the module transmitter has detected a fault condition related to laser operation or safety. The TX_Fault output contact is an open drain/collector and shall be pulled up to the Vcc_Host in the host with a resistor in the range 4.7-10 kΩ. TX_Disable is a module input contact. When TX_Disable is asserted high or left open, the SFP28 module transmitter output shall be turned off. This contact shall be pulled up to VccT with a 4.7 kΩ to 10 kΩ resistor.

The receiver converts 25Gbit/s serial optical data into serial PECL/CML electrical data. An open collector compatible Loss of Signal is provided. Rx_LOS when high indicates an optical signal level below that specified in the relevant standard. The Rx_LOS contact is an open drain/collector output and shall be pulled up to Vcc_Host in the host with a resistor in the range 4.7-10 k Ω , or with an active termination. Power supply filtering is recommended for both the transmitter and receiver. The Rx_LOS signal is intended as a preliminary indication to the system in which the SFP28 is installed that the received signal strength is below the specified range. Such an indication typically points to non-installed cables, broken cables, or a disabled, failing or a powered off transmitter at the far end of the cable.

optech

Pin Assignment

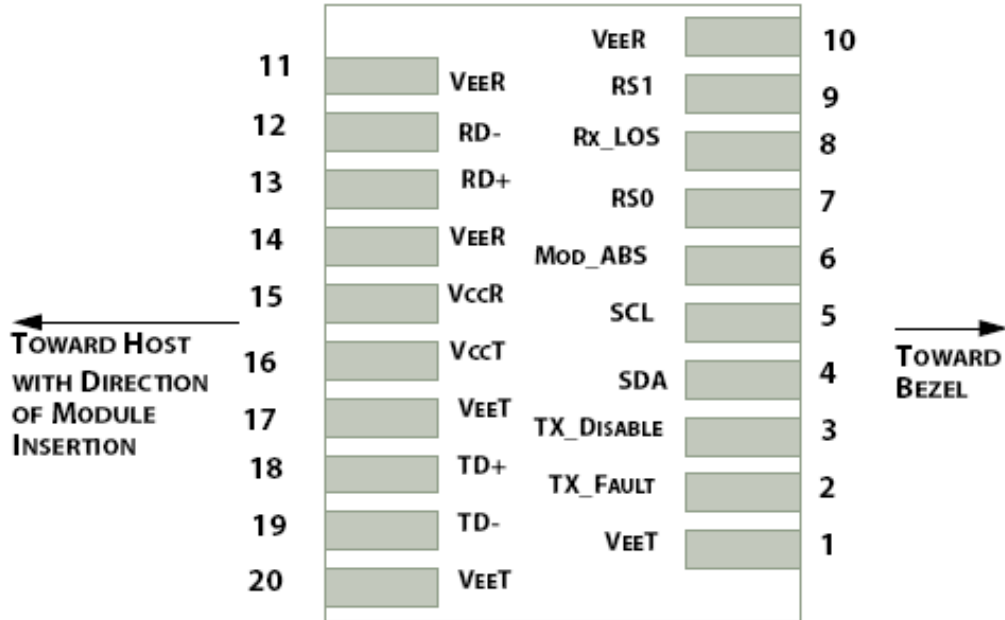

Module Interface to Host

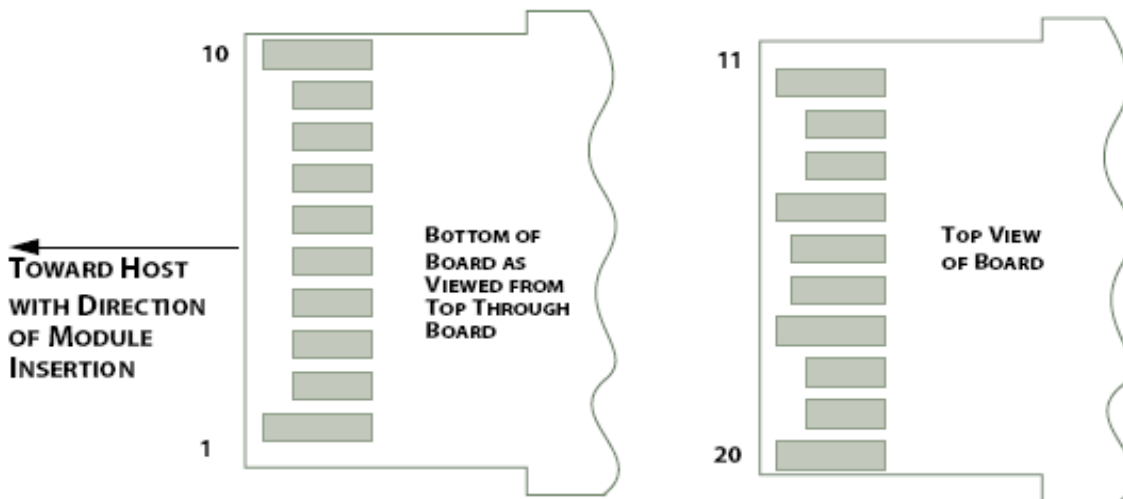

Module Contact Assignment

Pin Descriptions

<i>PIN</i>	<i>Logic</i>	<i>Symbol</i>	<i>Name / Description</i>	<i>Note</i>
1		VeeT	Module Transmitter Ground	1
2	LVTTL-O	TX_Fault	Module Transmitter Fault	
3	LVTTL-I	TX_Dis	Transmitter Disable; Turns off transmitter laser output	
4	LVTTL-I/O	SDA	2-Wire Serial Interface Data Line	2
5	LVTTL-I	SCL	2-Wire Serial Interface Clock	2
6		MOD_DEF0	Module Definition, Grounded in the module	
7	LVTTL-I	RS0	Receiver Rate Select	
8	LVTTL-O	RX_LOS	Receiver Loss of Signal Indication Active LOW	
9	LVTTL-I	RS1	Transmitter Rate Select (not used)	
10		VeeR	Module Receiver Ground	1
11		VeeR	Module Receiver Ground	1
12	CML-O	RD-	Receiver Inverted Data Output	
13	CML-O	RD+	Receiver Data Output	
14		VeeR	Module Receiver Ground	1
15		VccR	Module Receiver 3.3 V Supply	
16		VccT	Module Receiver 3.3 V Supply	
17		VeeT	Module Transmitter Ground	1
18	CML-I	TD+	Transmitter Non-Inverted Data Input	
19	CML-I	TD-	Transmitter Inverted Data Input	
20		VeeT	Module Transmitter Ground	1

Note:

1. Module ground pins GND are isolated from the module case.2. Shall be pulled up with 4.7K-10Kohms to a voltage between 3.15V and 3.45V on the host board.
2. Shall be pulled up the voltage between 3.15V and 3.47V with 4.7K – 10Kohms on the host board.

Dimensions

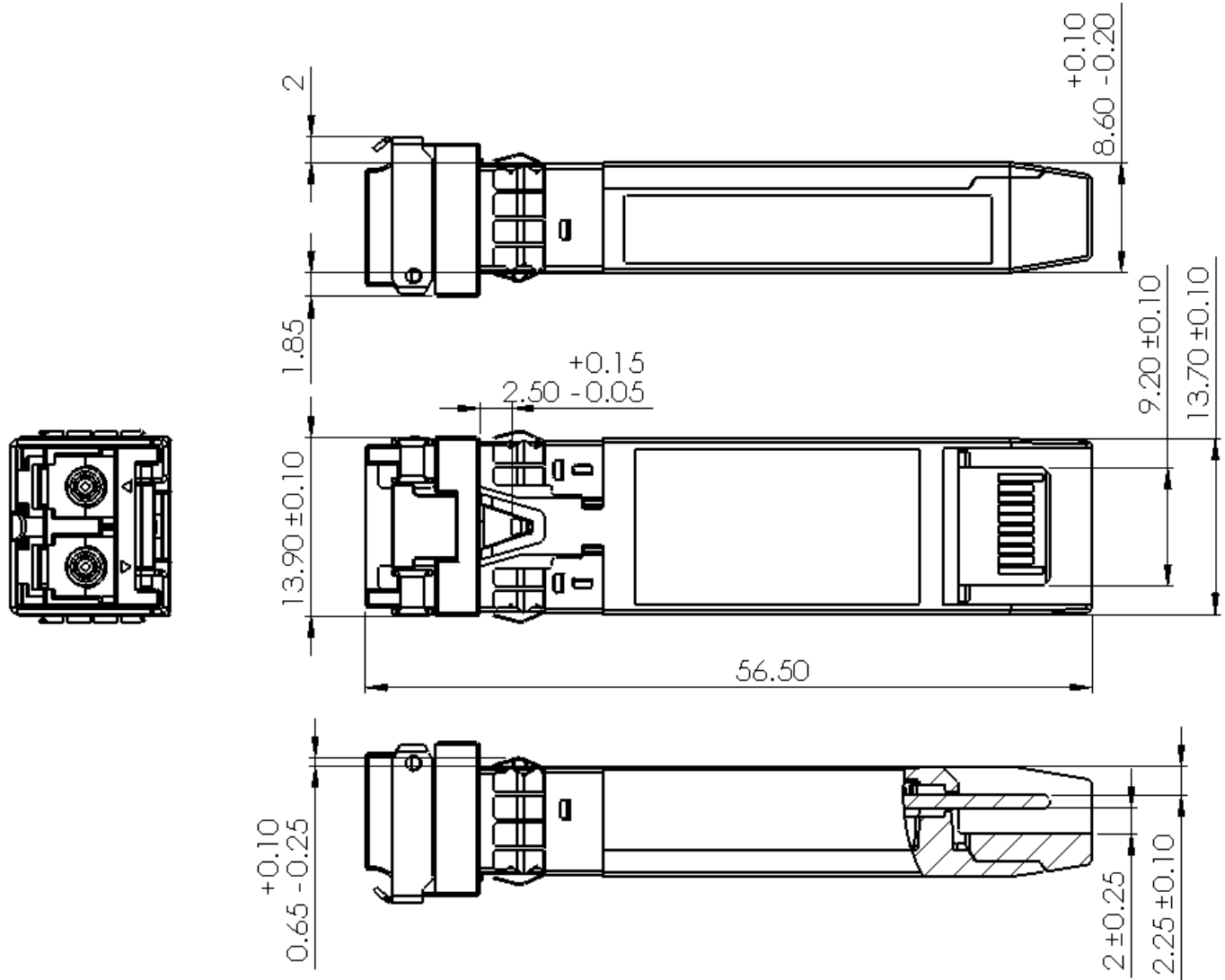

Optical Receptacle Cleaning Recommendations:

All fiber stubs inside the receptacle portions were cleaned before shipment. In the event of contamination of the optical ports, the recommended cleaning process is the use of forced nitrogen. If contamination is thought to have remained, the optical ports can be cleaned using a NTT international Cletop® stick type and HFE7100 cleaning fluid. Before the mating of patch-cord, the fiber end should be cleaned up by using Cletop® cleaning cassette.

Cleaning of patch-cord



Cleaning of fiber stub

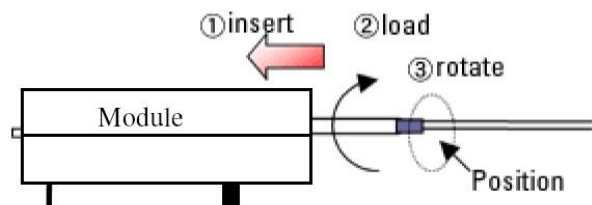

1. Insert
Ensure that stick is held straight when inserting into sleeve.
2. Load
Apply sufficient pressure (approx 600-700g) to ensure ferrule a little depressed in sleeve.
3. Rotate
Rotate stick clockwise 4-5 times, while ensuring direct contact with ferrule end-face is maintained.

*Notice: Number of possible wipes:
Maintenance (repair) ~1 use / piece
Equipment construction: 4 uses / piece (max.)*

Note: The pictures were extracted from NTT-ME website. And the Cletop® is a trademark registered by NTT-ME

Ordering Information

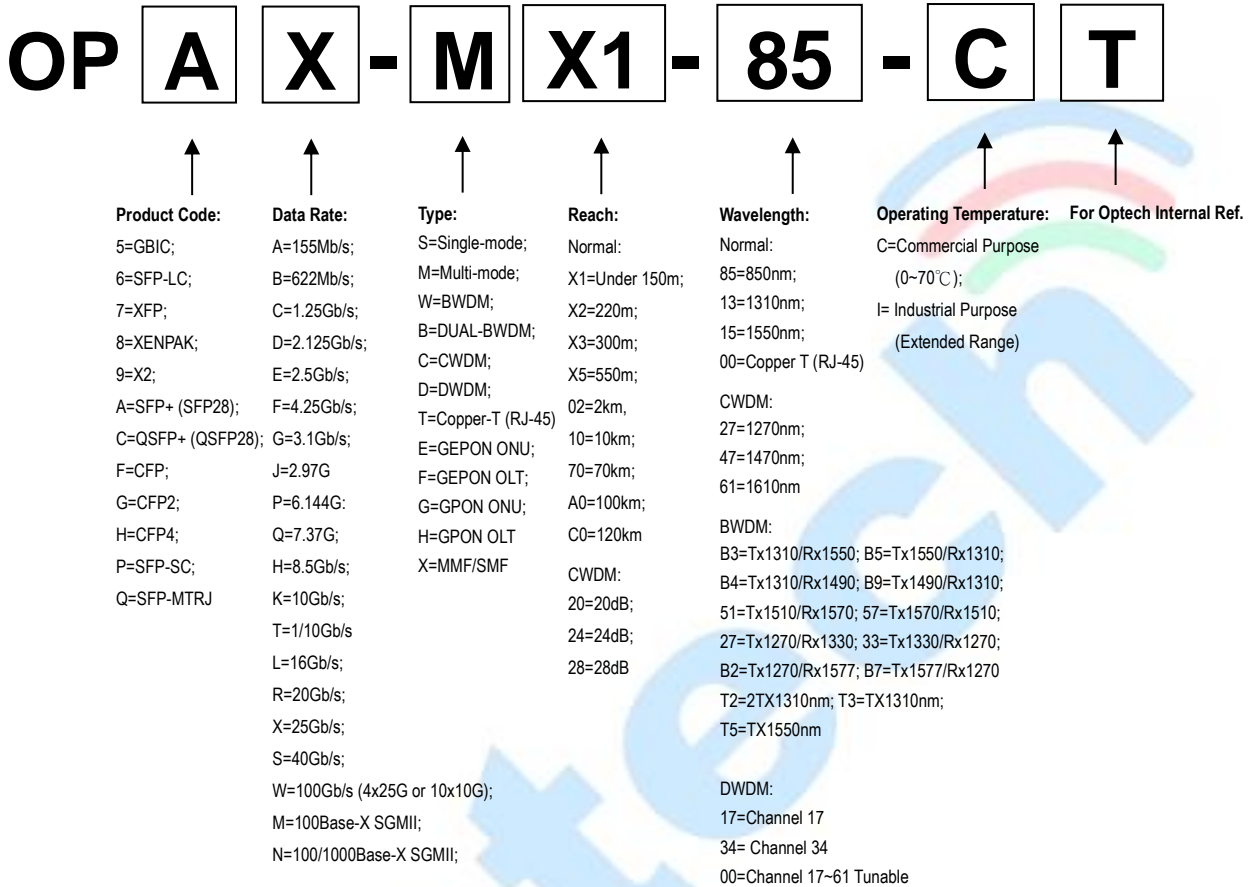

Model Number	Part Number	Reach	Input/Output	Signal Detect	Voltage	Temperature
SFP28-10/25G-SR	OPAX-MX1-85-CT	100m	AC/AC	TTL	3.3V	0°C to 70 °C

Note: All information contained in this document is subject to change without notice.